



**No. B 2254**  
August 2016

## Measurements of bus emissions 2010-2015

Martin Jerksjö, Åsa Hallquist



In cooperation with Västtrafik

**Author:** Martin Jerksjö and Åsa Hallquist, IVL

**Funded by:** the foundation of IVL Swedish Environmental Research Institute and Västtrafik

**Photographer:** Jonathan Westerlund

**Report number** B 2254

**ISBN** 978-91-88319-06-7

**Edition** Only available as PDF for individual printing

**© IVL Swedish Environmental Research Institute 2016**

IVL Swedish Environmental Research Institute Ltd.

P.O Box 210 60, S-100 31 Stockholm, Sweden

Phone +46-(0)10-7886500 //Fax +46-(0)10-7886590 // [www.ivl.se](http://www.ivl.se)

This report has been reviewed and approved in accordance with IVL's audited and approved management system.

## Table of contents

|       |   |    |
|-------|---|----|
| 1     | Introduction .....  | 6  |
| 2     | Equipment.....  | 8  |
| 3     | Testing procedure.....  | 9  |
| 3.1   | Experimental setup .....  | 10 |
| 4     | Locations.....  | 11 |
| 4.1   | Controlled measurements at bus depots.....                              | 11 |
| 4.2   | On-road measurements 2014 .....   | 11 |
| 5     | Results.....  | 12 |
| 5.1   | Measurements at bus depots.....   | 12 |
| 5.1.1 | NO <sub>x</sub> emissions by Euro standard .....                        | 13 |
| 5.1.2 | PM emissions by Euro standard.....                                      | 15 |
| 5.1.3 | NO <sub>x</sub> and PM emissions from diesel vs RME fuelled buses.....  | 17 |
| 5.1.4 | Emission trends of buses measured more than once (different years)..... | 19 |
| 5.1.5 | Emission differences of buses tested both on diesel and 100% RME.....   | 22 |
| 5.2   | On-road measurements .....  | 23 |
| 5.2.1 | NO <sub>x</sub> differences between manufacturers/Technology.....       | 24 |
| 5.2.2 | Buses compared to passenger cars.....                                   | 25 |
| 6     | Conclusions and discussion .....  | 26 |
|       | References .....  | 28 |
|       | Appendix 1 .....  | 29 |

## Summary

In this report results from measurements of exhaust emissions from buses conducted by IVL between 2010 and 2015 are presented. The measurements are parts of three different studies of which the latest was conducted between 2014 and 2015. The measured emissions from all studies form a relatively large data set, which may be used for various analyses. This is the reason why IVL has chosen to present results from all three studies in this report, even if the focus lies on the latest study. The main objectives of the latest study were to:

- measure emissions from Euro VI buses.
- measure both NO (nitrogen oxide) and NO<sub>2</sub> (nitrogen dioxide) and not only NO which was the case in the previous studies.
- measure emissions from buses driving in real world traffic and not only during controlled conditions as was the case in the previous studies.

In this report emissions of nitrogen oxides (NO<sub>x</sub>), carbon monoxide (CO) and particle mass (PM) are presented. The emissions have been analysed with respect to Euro class, exhaust aftertreatment and fuel type. The most important findings were:

- The average emissions of NO<sub>x</sub> and particles from the tested Euro VI buses are significantly lower than from the tested Euro V buses.
- The median particle emission from Euro V buses driving on 100% RME (Rapeseed Methyl Esther) was 88% lower compared to buses driving on (low blended) diesel. This result is based on measurements of buses from only one manufacturer.
- The median nitrogen oxide emission from Euro V buses driving on 100% RME was 35% higher compared to buses driving on (low blended) diesel. This result is based on measurements on buses from only one manufacturer. However, the difference of the average values was not statistically significant.
- No decrease in NO<sub>x</sub> emissions was observed going from Euro III to Euro V.
- A constant decrease of particle emissions (by mass) was observed going from Euro III to Euro VI, with the exception of Euro IV buses using EGR.
- Measured average NO<sub>2</sub> share of NO<sub>x</sub> is in relatively good accordance with data from the road vehicle emission model HBEFA. However, the results indicate that the ratio is not only dependent on the Euro standard and the exhaust aftertreatment system but also on vehicle manufacturer.
- Three out of the six buses which were tested fuelled with both (low blended) diesel and 100% RME did show a reduction of particle emissions when fuelled with RME. The remaining three buses showed an increase in PM emissions and a simultaneous increase in CO emissions.

## Sammanfattning

I denna rapport presenteras resultat från mätningar av bussemissioner utförda av IVL mellan 2010 och 2015. Mätningarna har utfört inom tre olika studier varav mätningarna i den senaste studien utfördes under 2014 och 2015. Tillsammans utgör mätdata från alla studierna ett relativt stort underlag för analyser, vilket är anledningen till att IVL valt att presentera även mätresultat från de tidigare studierna i denna rapport. Fokus i rapporten ligger dock på studien som utfördes 2014-2015. Huvudsyftena med den senaste studien var att:

- Mäta emissioner från Euro VI bussar.
- Mäta både kväveoxid (NO) och kvävedioxid (NO<sub>2</sub>) och inte bara NO som varit fallet i de tidigare studierna.
- Mäta utsläpp från fordon som kör i verklig trafik och inte som i de tidigare studierna bara under kontrollerade förhållanden på gårdsplanerna hos bussoperatörerna.

De utsläpp som presenteras i denna rapport är NO<sub>x</sub> (kväveoxider), CO (kolmonoxid) och PM (partikelmassa). Utsläppen har studerats dels som trender över de olika euroklasserna, men även skillnader i utsläpp med olika avgasreningssystem och skillnader i utsläpp mellan fordon som kör på diesel respektive 100 % RME (rapsmetylester) har studerats, liksom skillnader mellan olika tillverkare.

De viktigaste resultaten var:

- Genomsnittliga utsläpp av NO<sub>x</sub> och partiklar från testade Euro VI bussar är signifikant lägre än från testade Euro V bussar.
- Medianvärdet för partikelutsläpp från Euro V bussar som körde på 100 % RME var 88 % lägre jämfört med motsvarande bussar som körde på låginblandad diesel. Resultatet är baserat på mätningar från endast en tillverkare.
- Medianvärdet för kväveoxider från Euro V bussar som körde på 100 % RME var 35 % högre jämfört med motsvarande bussar som körde på låginblandad diesel. Resultatet är baserat på mätningar från endast en tillverkare. Skillnaden i medelvärdena var dock inte statistiskt signifikant.
- Ingen minskning i NO<sub>x</sub> emissioner mellan Euro III och Euro V.
- Succesivt minskande utsläpp av partiklar (som massa) från Euro III till Euro VI med undantag för Euro IV fordon med EGR.
- Uppmätt genomsnittlig NO<sub>2</sub> andel av NO<sub>x</sub> stämmer relativt bra överens med uppgifter från emissionsmodellen HBEFA. Resultat i denna studie tyder dock på att andelen inte bara skiljer mellan euro standarder och efterrengningsutrustning utan även mellan olika tillverkare.
- Av de sex bussar som testats både när de körde på diesel och när de körde på 100 % RME uppvisar tre en sänkning av partikelemissioner vid RME-drift. Övriga uppvisade en ökning av PM-emissionerna och samtidigt en ökning i emissionerna av CO.

# 1 Introduction

IVL and Västtrafik have within three research studies developed a method for detecting high emitting busses. The first study was carried out in 2010 and the other two during 2011-2012 and 2014-2015. The method is based on measurements of the gaseous species NO<sub>x</sub> (nitrogen oxides), CO (carbon monoxide) and HC (hydrocarbons) and PM (particle mass) in exhaust plumes during full throttle accelerations. The gaseous species are measured by a remote sensing device (RSD) and the particles are measured as particle number size distributions using an engine exhaust particle spectrometer (EEPS). From particle number size distributions the particle mass is estimated. The measurements are carried out during controlled conditions usually at the courtyard of the bus garages where the buses are stationed.

In 2010 the aim of the project was to identify high emitting buses (i.e. busses emitting significantly more than average buses of the same Euro standard) and for the first time use the recently developed method for measuring particle mass emissions from individual vehicles (Persson et al., 2010) in conjunction with the RSD measurements. The results from these measurements can be found in Hallquist et al., 2013.

The main focus in the second research project was to measure emissions from as many buses as possible to get a statistical significant data set with average emissions of different Euro classes etc. and to answer the following questions:

- What are the optimal measuring conditions and how do we get a method with high repeatability?
- What cut points should be used to identify high emitting vehicles?
- Is it possible to relate emissions measured with this method to how the vehicle will perform during on-board measurements (PEMS)?

These questions were studied and discussed in the project spanning from 2011-2012 and results have been described in detail in Jerksjö and Hallquist (2013). In the following project reaching from 2014-2015, which is presented in this report, even more emission data were gathered and the main objectives were:

- Measure emissions from Euro VI buses. This was not possible until 2014 when the first Euro VI buses were introduced.
- Measure both NO and NO<sub>2</sub> and not only NO which was the case in the previous studies.
- Measure emissions from roadside, to gather a lot of data and compare results from the controlled measurements at the bus depots.
- Compare emission trends by Euro class for buses and emission trends for other road vehicles.

All together IVL has measured emissions during full throttle acceleration from 218 unique buses during 2010-2015. If including the road side measurements the number is even larger.

Among these buses different Euro standards, model years, fuels and exhaust aftertreatment systems are represented. The number of Euro VI buses tested was in total 15 whereof two were methane fuelled, nine RME (Rapeseed methyl ester) fuelled and four were electrical hybrids fuelled with RME. The measurements have been carried out at 17 different bus depots in Western Sweden, where some have been visited more than once. The total NO<sub>x</sub> (NO + NO<sub>2</sub>) measurements were conducted at two of the bus operators and during a five day roadside measurement campaign. In the other cases only NO was measured.

## 2 Equipment

The gaseous species have been measured using either of two different remote sensing devices (RSD). Both instruments generate a light beam across the driving lane and measure concentration ratios of the pollutants to the concentration of CO<sub>2</sub> by measuring absorption at certain wavelengths used for detecting each species. Relating to CO<sub>2</sub> facilitates quantitative measurements of pollutants despite not knowing the extent of exhaust gas dilution. Emissions measured with RSD are often expressed as ratios to CO<sub>2</sub>, or mass of pollutant per mass of fuel. In this report the latter is used.

Most RSD measurements were performed with an AccuScan RSD-3000 instrument. This instrument measures NO, CO and HC. One main drawback of this instrument is its inability to measure NO<sub>2</sub> and therefore it only measures a part of the total NO<sub>x</sub> emissions. The NO<sub>2</sub>/NO<sub>x</sub>-ratio varies between different manufacturers, emission standards and exhaust aftertreatment systems and in some cases the total NO<sub>x</sub> emissions is dominated by NO and primary emitted NO<sub>2</sub> only contributes to a few percent. In other cases though, the shares of NO, and primary emitted NO<sub>2</sub> is equal. If there is knowledge about NO<sub>2</sub>/NO<sub>x</sub>-ratios by certain exhaust aftertreatment systems etc. total NO<sub>x</sub> can be estimated by only measuring NO, but preferably both NO and NO<sub>2</sub> should be measured.

When this study was conducted there was no commercial available on-road vehicle RSD capable of measuring NO<sub>2</sub>. There were though a RSD, constructed at the University of Denver (hereinafter referred to as the RSD<sub>DU</sub>), with the capability of measuring NO, NO<sub>2</sub>, NH<sub>3</sub>, SO<sub>2</sub>, CO and HC. This instrument has been described in detail earlier by e.g. Burgard, et al., (2006). With the main purpose of being able to measure both NO and NO<sub>2</sub> this instrument was rented for 3 months during the summer of 2014. Both the Accuscan RSD-3000 and the RSD<sub>DU</sub> also measures opacity in the IR-range. This parameter gives an approximation of the particle emissions but it was not evaluated in this study since it is considered to be too uncertain. Instead an EEPS (Engine Exhaust Particle Sizer Spectrometer, TSI Inc. Model 3090) was used. This instrument measures the number size distribution of particles in the range from 5.6 to 560 nm with a time resolution of 10 Hz. When estimating the particle mass, spherical particles with a density of 1 g cm<sup>-3</sup> was assumed. The measured particle emissions were also related to CO<sub>2</sub> as is the case for the gaseous species measured with the RSD. For the particles measurements CO<sub>2</sub> was measured using a non-dispersive infrared gas analyser (LI-840A) with a time resolution of 1 Hz. The sampling of the particle and the CO<sub>2</sub> emissions was conducted by using an extractive sampling of the passing bus exhaust plumes where the sample was continuously drawn through a cord-reinforced flexible conductive tubing. To prevent the influence of the ambient temperature on the measurement a thermodenuder (TD) was used in front of the EEPS with which the sample temperature was regulated to 298K. Figure 1 shows a schematic of the experimental setup.



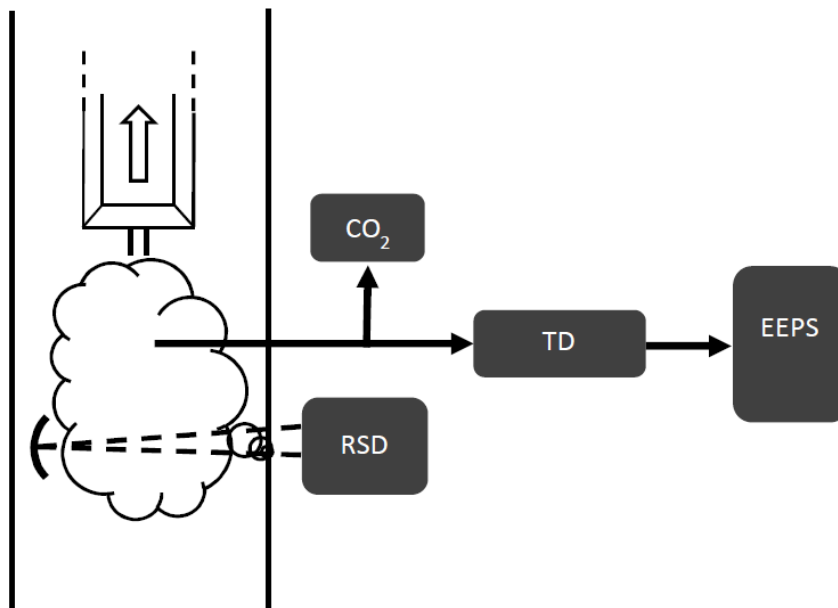

Figure 1 Schematic of the experimental set-up used (Hallquist et al., 2013).

### 3 Testing procedure

The emissions from the buses were measured during full throttle accelerations from stand still. Prior the test, a warm-up route was driven, typically 5-10 minutes, to prevent cold engines. The length and driving conditions during the warm-up routes did vary depending on where the buses were stationed. When warmed up, the bus stopped right before the instrument set-up. On a given signal it accelerated, passing the instruments and the emissions were measured. After the first measurement the bus turned around and did a few more accelerations past the instruments until at least three valid measurements had been obtained. The aim was to test ten buses at each bus garage; this was often accomplished during seven hours including instrumental set-up. The testing conditions were similar to conditions when buses in real-traffic accelerate from e.g. a bus stop or a traffic light. This means that the measured emissions are representative for “stop and go” traffic, normally occurring in city centres, but are not representative for emissions during e.g. motorway driving.

Today many buses use SCR (Selective Catalytic Reduction) catalysts in order to reduce nitrogen oxides. The efficiency of these catalysts is strongly dependent on the exhaust temperature. Since the exhaust temperature was not measured during these tests it was not possible to determine if high NO<sub>x</sub> emissions from SCR-equipped buses is a consequence of low exhaust temperature or e.g. a malfunctioning catalyst.

## 3.1 Experimental setup

Three different instrumental set-ups were used in this study.

### Setup 1

The first setup consisted of the AccuScan RSD 3000 and the EEPS. It was used for all the measurements performed at the bus depots, except for two where Setup 2 was used.

### Setup 2

The second setup consisted of the RSD<sub>DU</sub> and the EEPS. It was used at two of the bus depots in 2014 (Nettbuss and Veolia).

### Setup 3

The third setup consisted of only the RSD<sub>DU</sub>. This setup was used for doing the five day roadside measurements.

## 4 Locations

This report presents results from both the controlled measurements during full throttle accelerations at bus depots 2010-2015 and roadside measurements in 2014. Details about the measurement sites used are presented in the following sections.

### 4.1 Controlled measurements at bus depots

From 2010-2015 measurements have been conducted at 17 depots and some of them were visited more than once. A list of all the depots is included in Appendix 1. At all occasions the measurements could be conducted on the courtyards belonging to the bus operators. The requirements for a measurement site are that the measurements can be done safely for everyone staying in the area, that there is enough room for the buses to accelerate past the instrument set-up, slow down and return to the instruments, stable background levels of particles and CO<sub>2</sub> and finally access to nearby roads that can be used for a long enough warm up route.

### 4.2 On-road measurements 2014

The on-road measurements with the RSD<sub>DU</sub> were carried out at three different locations in Gothenburg during the summer of 2014. The first location was at Burggrevegatan. This is a bus-only road in the central parts of Gothenburg. The second site was a motorway on-ramp for accessing E6 south of Örgrytevägen. The third site was an on-ramp at Gullbergsmotet where vehicles coming from Tingstadstunneln head west. Table 1 shows the number of measurements at each site and also average speed and acceleration of the measured buses. These averages are based on all valid speed and acceleration measurements but there were also quite a few passages where the instrument failed to measure these parameters even though the emission measurements were valid. However, there were enough valid measurements to consider the averages as representatives for the sites.

**Table 1 Information about the measurement sites.**

|   | Gullbergsmotet | Örgrytevägen | Burggrevegatan |
|---|----------------|--------------|----------------|
| <b>Valid measurements</b>                     | 14             | 364          | 106            |
| <b>Unique buses</b>                           | 14             | 161          | 77             |
| <b>Average speed (km/h)</b>                   | 42             | 19           | 19             |
| <b>Average acceleration (m/s<sup>2</sup>)</b> | 0.38           | 0.29         | 0.2            |

## 5 Results

Most of the measurements of nitrogen oxides during full throttle acceleration in the studies conducted from 2010 to 2015 were done with the AccuScan RSD 3000, which does not measure NO<sub>2</sub>. The total NO<sub>x</sub> emissions have been estimated by using general NO<sub>2</sub>/NO<sub>x</sub> ratios from the HBEFA road emission model (HBEFA, 2015) or ratios estimated by IVL from RSD<sub>DU</sub> measurements. Since the NO<sub>2</sub> part in most cases is approximations some of the figures in this section instead present measured NO.

In general, this section presents median values of emissions from buses of e.g. a specific Euro standard. This will give a value more representative of the Euro standard compared to the mean since the mean will be affected by possible high emitters. However, in some cases the averages are presented together with the 95% confidence interval.

All measured emission factors are expressed as mass of pollutant per kg fuel burnt and are notated as EF<sub>NO</sub>, EF<sub>PM</sub> etc.

### 5.1 Measurements at bus depots

In total 218 unique buses were measured at the depots during the period 2010-2015. Fifteen of the buses were measured twice and one was measured three times during the six year period. The emission standard of the tested buses ranged from Euro II to Euro VI. Some of the tested Euro V diesel buses were in the vehicle register referred to as EEV. According to Västtrafik and in some cases the bus operator these buses were specified to comply with the Euro V standard but not the EEV standard. Since it was not clear how to classify these vehicles all diesel buses referred to as EEV in the register are referred to as Euro V vehicles in this report. Further, different techniques for reducing NO<sub>x</sub> and particles are represented among the buses. Information about Euro standard and exhaust aftertreatment systems was obtained from the bus operators or Västtrafik. Some of the information from the operators was found during the data evaluation to be wrong, especially regarding information about the presence of particle abatement systems for Euro IV and Euro V buses. However, most of this incorrect information could be corrected by contacting the vehicle manufacturers. The manufacturers have different implementation of the aftertreatment systems. This is important to remember since the emissions will depend not only on the technique but also on bus/engine manufacturer. Table 2 shows a summary of all the measured buses with respect to fuel type, Euro class and technology. Also the measured mean and median emission factors of NO<sub>x</sub> (EF<sub>NO<sub>x</sub></sub>) and PM (EF<sub>PM</sub>) are presented in the table. Information about the fuel was obtained from the bus operators. Some buses, mostly Euro V and Euro VI vehicles, were fuelled with 100% RME. When it comes to diesel there may be a mix of different low blends of RME and HVO. Since IVL does not have this detailed information all low blends are termed as diesel. The used fossil diesel was in all cases Swedish MK1 diesel (Swedish Environmental Class 1).

**Table 2 Number of tested buses and EF<sub>NOx</sub> and EF<sub>PM</sub> by fuel, Euro standard and exhaust aftertreatment system. HEV = Hybrid electric vehicle, DF = dual fuel (diesel and methane). Dual fuel buses where operated on diesel when tested.**

| Fuel         | Euro std. | NOx/PM reduction system | Hybrid | #*         | #**        | EF <sub>NOx</sub> |      |        | EF <sub>PM</sub> |      |        |
|--------------|-----------|-------------------------|--------|------------|------------|-------------------|------|--------|------------------|------|--------|
|              |           |                         |        |            |            | Median            | Mean | 95% CI | Median           | Mean | 95% CI |
| Diesel       | E II      |                         |        | 2          | 2          | 22                | 22   | 69     | 819              | 259  | 2325   |
| Diesel       | E III     |                         |        | 11         | 7          | 12                | 14   | 6      | 1571             | 1794 | 668    |
| Diesel       | E III     | DPF                     |        | 17         | 16         | 13                | 16   | 5      | 188              | 229  | 134    |
| Diesel       | E III     | SCR+DPF                 |        | 5          | 4          | 22                | 26   | 19     | 6                | 507  | 1360   |
| Diesel       | E III     | EGR+DPF                 |        | 1          | 1          |                   | 18   |        |                  | 61   |        |
| Diesel       | E IV      | SCR                     |        | 4          | 4          | 10                | 13   | 21     | 222              | 746  | 1746   |
| Diesel       | E IV      | EGR                     |        | 12         | 12         | 14                | 15   | 7      | 650              | 1151 | 719    |
| Diesel       | E V       | SCR                     |        | 42         | 42         | 22                | 27   | 6      | 257              | 301  | 66     |
| Diesel       | E V***    | SCR+DPF                 |        | 4          | 4          | 20                | 21   | 9      | 1                | 1    | 2      |
| Diesel       | E V       | EGR+DPF                 |        | 5          | 5          | 11                | 13   | 8      | 36               | 54   | 62     |
| Diesel       | E V       | SCR                     | HEV    | 7          | 7          | 30                | 27   | 1      | 41               | 45   | 23     |
| RME          | E III     | SCR+DPF                 |        | 2          | 2          | 38                | 38   | 4      |                  | 68   |        |
| RME          | E IV      | SCR                     |        | 6          | 6          | 40                | 39   | 24     | 233              | 268  | 262    |
| RME          | E IV      | EGR                     |        | 2          | 2          | 13                | 13   | 16     | 72               | 72   | 197    |
| RME          | E V       | SCR                     |        | 23         | 22         | 38                | 38   | 7      | 28               | 59   | 26     |
| RME          | E V       | EGR+DPF                 |        | 7          | 7          | 10                | 10   | 5      | 61               | 64   | 35     |
| RME          | E V       | SCR                     | HEV    | 10         | 10         | 42                | 39   | 11     | 19               | 21   | 9      |
| RME          | E V       | SCR                     | DF     | 10         | 10         | 36                | 35   | 2      | 77               | 82   | 7      |
| RME          | E VI      | EGR+SCR                 |        | 9          | 9          | 4                 | 4    | 2      | 1                | 2    | 2      |
| RME          | E VI      | EGR+SCR                 | HEV    | 4          | 4          | 7                 | 13   | 24     | 1                | 1    | 1      |
| Methane      | E V/EEV   |                         |        | 50         | 46         | 0                 | 30   | 11     | 8                | 23   | 13     |
| Methane      | E VI      |                         |        | 2          | 2          | 0.45              | 0.45 | 0.32   | 2                | 2    | 17     |
| <b>Total</b> |           |                         |        | <b>235</b> | <b>224</b> |                   |      |        |                  |      |        |

\* In this column every bus that was tested two or three times are counted two or three times respectively.

\*\* In this column every bus that was tested two or three times and not have changed from diesel to RME are counted only once. Six of the buses were tested both on diesel and RME; hence these buses are included twice in this column.

\*\*\* Mini buses

### 5.1.1 NO<sub>x</sub> emissions by Euro standard

Measured EF<sub>NOx</sub> for all buses are shown in **Error! Reference source not found.** together with the median values of each Euro class/technology. The figure shows that there is no significant decrease in NO<sub>x</sub> emissions going from Euro III to Euro V for the conditions used in the controlled measurements. As is seen in Figure 2, buses equipped with an SCR-catalyst have approximately twice the emissions of EGR equivalents. This is most likely due the SCR not operating at optimal conditions during the tests. The tested Euro VI (diesel) buses though, use both SCR and EGR and the measured NO<sub>x</sub> emissions from these buses were several times lower than the emissions from the Euro V buses and did not show any sign of significant increases in NO<sub>x</sub> even after longer periods of stand still. When it comes to methane powered buses, the very high median emissions are due to some groups of buses emitting high amount of NO<sub>x</sub>.

Figure 3 shows  $EF_{NO}$  for methane powered buses by manufacturer (M1-M4), model year and age of the vehicle when tested. The M1 buses operates under lean burn conditions, the M2 buses use a mix of lean burn and stoichiometric conditions depending on load and the speed of the engine which is also the case for the M4 buses. The M3 operates under stoichiometric conditions. In a complete analysis of the emission behaviour from the different manufacturers there are even more parameters that should be considered, e.g. different models from the same manufacturer, kilometres driven and maintenance. The differences between models from the same manufacturer did not show any significant differences and this information was chosen not to be included in the analysis. When it comes to driven kilometres, IVL did get information about only a few of the buses and we do not have any information at all about when the buses were serviced. Emissions of NO from two of the manufacturers (M3 and M4) were low regardless of vehicle age (median 1.5 g kg fuel<sup>-1</sup> and 4.9 g kg fuel<sup>-1</sup>). M2 showed a bit higher median emission (20 g kg fuel<sup>-1</sup>) compared to M3 and M4, also two really high emitters were identified from M2. The highest median emission was measured from manufacturer M1 (67 g kg fuel<sup>-1</sup>) and the variation in NO-emissions between the different individual buses within this brand was relatively large. Also, all the buses from M1 were owned by the same operator which may have an influence on the emissions, if e.g., all the buses have higher yearly driving distances than other buses and that the maintenance did differ from other operators. However, the reason for these differences between manufacturers was not further investigated during this study.

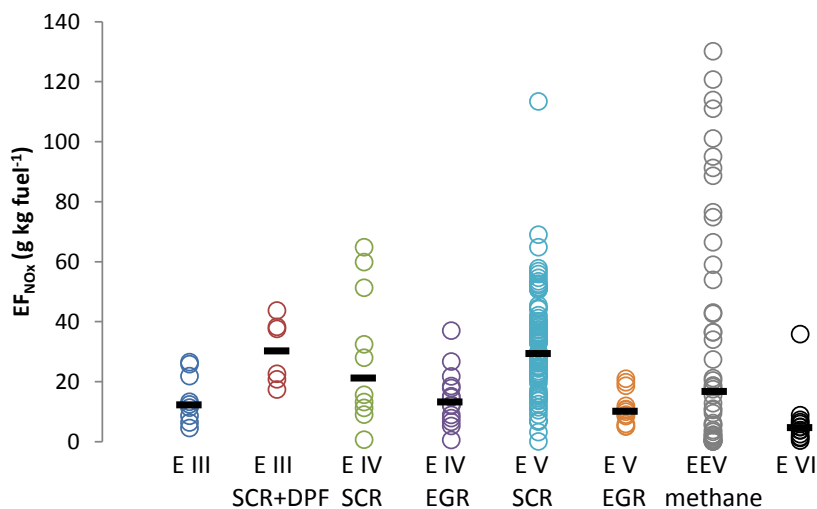

Figure 2 Measured  $EF_{NOx}$  from all buses by Euro standard and aftertreatment system (circles) and median  $EF_{NOx}$  (black lines).

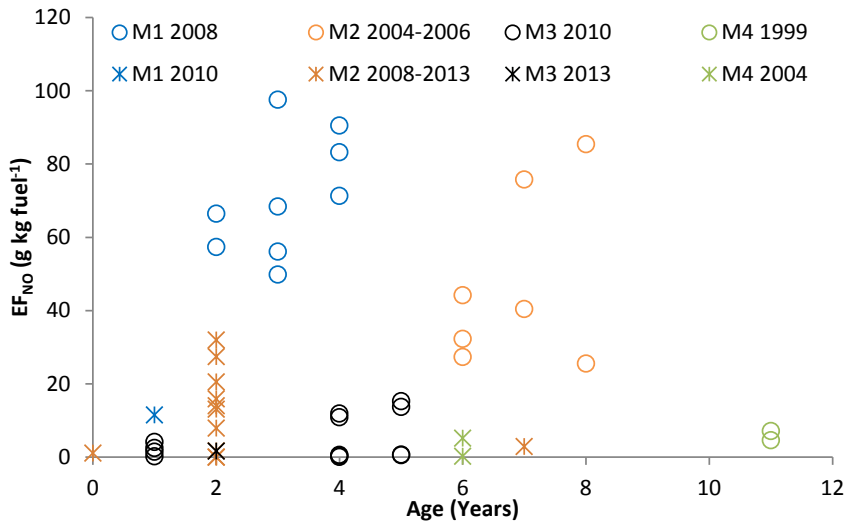

Figure 3 EF<sub>NO</sub> from methane powered buses by manufacturer, model year and age.

### 5.1.2 PM emissions by Euro standard

In Figure 4 the particle emissions (by mass) for all the tested buses are shown (excluding 11 retrofitted Euro III and Euro IV buses). There is a large variation in emissions between different classes but also within the Euro classes. Euro III (without DPF) and IV (EGR) have the largest median EF<sub>PM</sub> (1571 and 649 mg kg fuel<sup>-1</sup> respectively) and the EEV (methane fuelled) and the Euro VI buses have the lowest (8 and 1 mg kg fuel<sup>-1</sup> respectively).

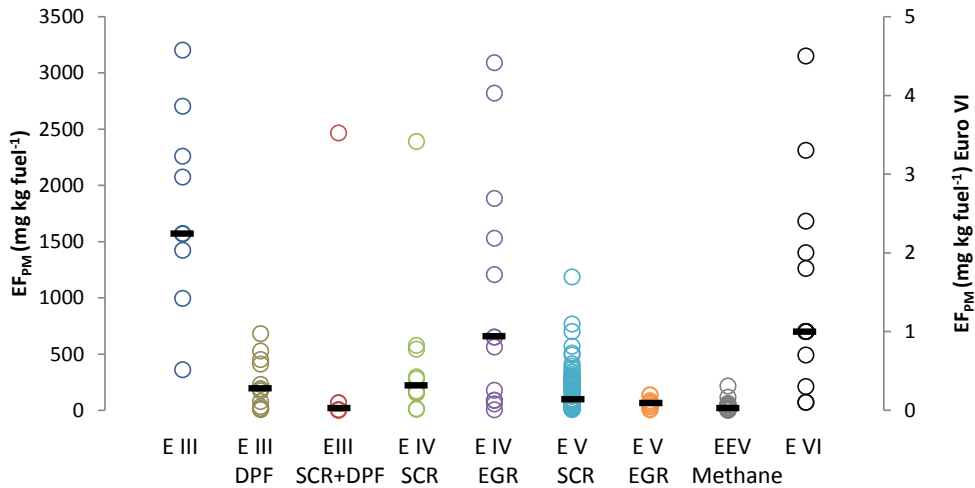
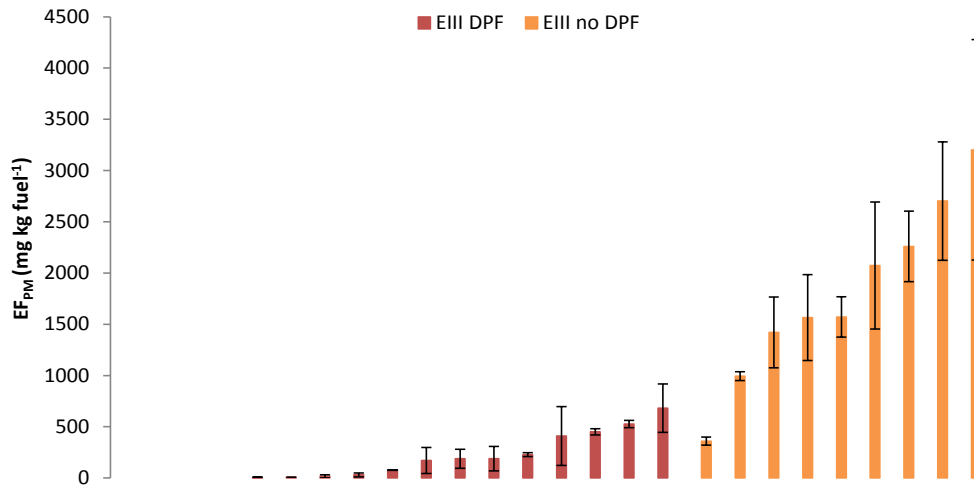

Figure 4 Measured EF<sub>PM</sub> from all buses by Euro standard and aftertreatment system (circles) and median EF<sub>PM</sub> (black lines). The secondary axis is for Euro VI.

Buses equipped with diesel particulate filter (DPF) are emitting significantly less particle mass compared to similar buses without DPF as is illustrated in Figure 5 for Euro III buses. The median EF<sub>PM</sub> with DPF is 188 mg kg fuel<sup>-1</sup> and the median EF<sub>PM</sub> without 1571 mg kg fuel<sup>-1</sup>,

respectively. The reason for high masses for some buses equipped with DPF may be malfunction of the DPF.



**Figure 5**  $EF_{PM}$  of Euro III buses equipped with (red) and without DPF (orange). Stated errors are at the statistical 95% confidence level.

Euro V was the most frequently tested emission standard during this study. In Figure 6, all the Euro V buses are shown and subdivided depending on fuel and  $NO_x$  abatement technology. For SCR buses the median  $EF_{PM}$  was higher for diesel buses compared to RME fuelled buses. For the EGR buses the median  $EF_{PM}$  was similar between the different fuel types, 36 and 61  $mg\ kg\ fuel^{-1}$ , respectively. However, these buses were equipped with DPF. Additionally, for the RME buses, the median  $EF_{PM}$  was similar for the EGR+DPF and SCR technologies (61 and 28  $mg\ kg\ fuel^{-1}$ , respectively).



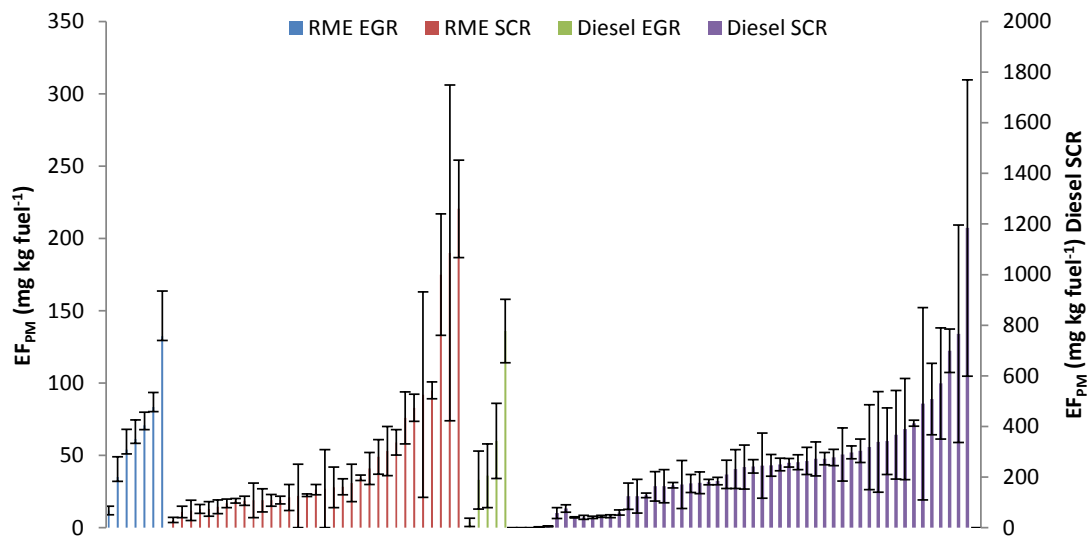

Figure 6 EF<sub>PM</sub> of the tested Euro V buses with respect to fuel and NO<sub>x</sub> abatement technology. The secondary y-axis is for Diesel SCR buses. Stated errors are at the statistical 95% confidence level.

### 5.1.3 NO<sub>x</sub> and PM emissions from diesel vs RME fuelled buses

Among the tested diesel buses there was a mixture between buses fuelled with conventional (low blended) diesel and 100% RME. This enabled an analysis of differences in emissions depending on the fuel. To minimize the number of parameters other than the fuel that may influence the emissions, only Euro V buses with SCR from one manufacturer were taken into account. When it comes to particle mass, the median emission from RME fuelled buses was 88% lower than the median for buses fuelled with low-blended diesel (30 mg kg fuel<sup>-1</sup> and 249 mg kg fuel<sup>-1</sup>, respectively), see Figure 7. The emissions from the RME fuelled buses were generally low, <100 mg kg fuel<sup>-1</sup>, whereas the scatter for diesel fuelled buses was much larger and ranged from 41 to 1200 mg kg fuel<sup>-1</sup>.

Any differences in NO<sub>x</sub>-emissions between the fuels are not as clear as for particle mass, Figure 8. This is in line with expectations as the NO<sub>x</sub> reduction system (SCR) is dependent on parameters such as the exhaust temperature which could not be controlled in this study. However, the median NO<sub>x</sub> emission from buses fuelled with low blended diesel was 35% higher than for RME fuelled buses (25 g kg fuel<sup>-1</sup> and 33 g kg fuel<sup>-1</sup>, respectively). Still it is not possible to determine if the measured difference in this study should be attributed to different fuels or if it is a consequence of different exhaust temperatures of the tested buses.

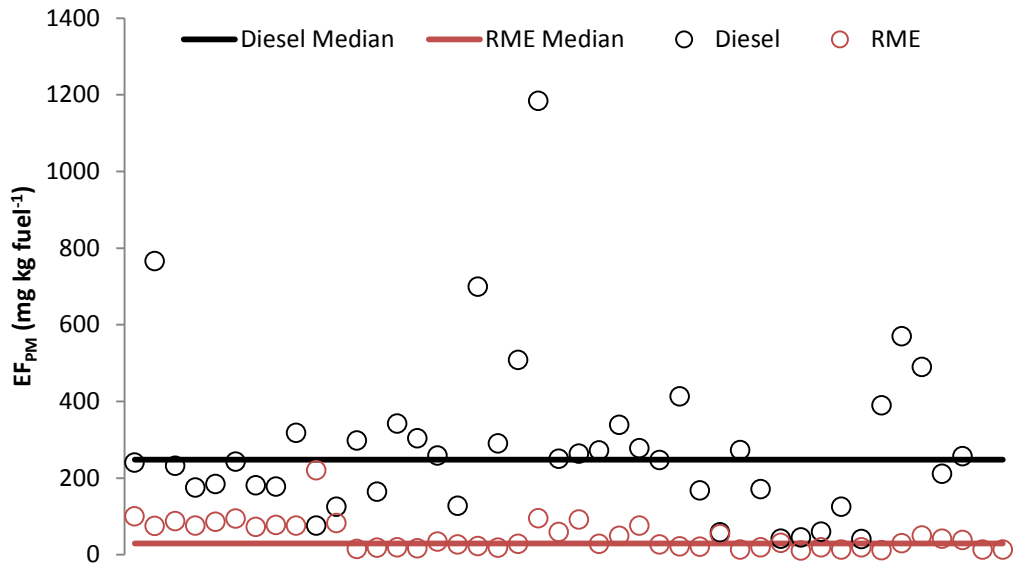

Figure 7 Median  $EF_{PM}$  for Euro V busses running on RME (red symbols) and diesel (black symbols).

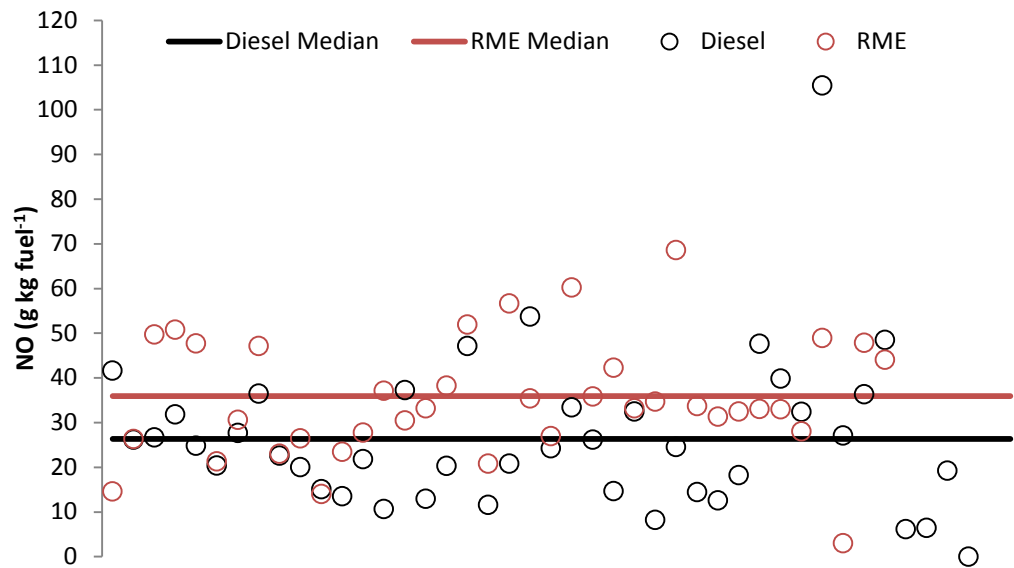

Figure 8 Median  $EF_{NO}$  for Euro V busses running on RME (red symbols) and diesel (black symbols).

## 5.1.4 Emission trends of buses measured more than once (different years)

Seventeen of the buses were analysed more than once, with one year or more between each occasion. One bus was tested on three different occasions and the others were tested on two different occasions. For most of the buses, the emissions of NO and PM were rather similar between the years but there were also cases with significant differences, see Table 3. For PM there was a positive relationship between  $EF_{PM}$  and  $EF_{CO}$  (Table 3, Figure 9). High  $EF_{CO}$  is an indication of incomplete combustion, favours soot formation and hence increased PM emissions. A significant change in particle emissions from one year to another gives a better indication of changes in real world emissions compared to NO. When it comes to NO-emissions one must take into account that the differences between years may be attributed to differences in the catalyst temperature and other parameters affecting the urea injection and NO<sub>x</sub> reduction for buses with SCR-catalyst. This is avoided as far as possible by having a test procedure which is the same each time. But since IVL does not have the opportunity to measure for example exhaust temperature and urea injection; it is not possible to draw conclusions about if the differences are consequences of measurement conditions or something else. Figure 10 shows changes in  $EF_{NO}$  between the years for busses when the measured difference was statistical significant.

**Table 3 Average EF<sub>NO</sub>, EF<sub>CO</sub> (g kg fuel<sup>-1</sup>) and EF<sub>PM</sub> (mg kg fuel<sup>-1</sup>) of buses tested more than once. HEV = Hybrid electric vehicle.**

| <b>ID</b> | <b>Euro standard</b> | <b>DPF</b> | <b>Year</b> | <b>Fuel</b> | <b>Hybrid</b> | <b>EF<sub>NO</sub></b> | <b>95% CI</b> | <b>EF<sub>CO</sub></b> | <b>95% CI</b> | <b>EF<sub>PM</sub></b> | <b>95% CI</b> |    |
|-----------|----------------------|------------|-------------|-------------|---------------|------------------------|---------------|------------------------|---------------|------------------------|---------------|----|
| B1        | Euro IV              | EGR        | No          | 2010        | Diesel        | 15                     | 4.2           | 4.0                    | 2.6           | 562                    | 469           |    |
| B1        | Euro IV              | EGR        | No          | 2015        | RME           | 9.1                    | 2.0           | 4.8                    | 3.2           | 56                     | 7             |    |
| B2        | Euro IV              | SCR        | No          | 2011        | Diesel        | 8.3                    | 12            | 25                     | 12            | 166                    | 50            |    |
| B2        | Euro IV              | SCR        | No          | 2015        | RME           | 60                     | 71            | 60                     | 23            | 295                    | 63            |    |
| B3        | Euro V               | EGR        | Yes         | 2010        | Diesel        | 6.7                    | 2.7           | 1.0                    | 1.3           | 4                      | 3             |    |
| B3        | Euro V               | EGR        | Yes         | 2015        | RME           | 4.4                    | 0.60          | 3.1                    | 1.2           | 12                     | 3             |    |
| B4        | Euro V               | SCR        | No          | 2014        | RME           | 69                     | 2.3           | 4.6                    | 0.62          | 92                     | 71            |    |
| B4        | Euro V               | SCR        | No          | 2015        | RME           | 60                     | 3.2           | 4.2                    | 1.0           | 76                     | 18            |    |
| B5        | Euro V               | SCR        | No          | 2012        | Diesel        | HEV                    | 27            | 1.5                    | 0.80          | 0.64                   | 60            | 10 |
| B5        | Euro V               | SCR        | No          | 2015        | RME           | HEV                    | 52            | 4.1                    | 3.6           | 1.3                    | 11            | 4  |
| B6        | Euro V               | SCR        | No          | 2012        | Diesel        | HEV                    | 26            | 2.2                    | 0.44          | 0.55                   | 125           | 66 |
| B6        | Euro V               | SCR        | No          | 2015        | RME           | HEV                    | 48            | 2.5                    | 1.9           | 0.88                   | 19            | 8  |
| B7        | Euro III             |            | Yes         | 2010        | Diesel        | 13                     | 1.2           | 3.0                    | 2.9           | 681                    | 236           |    |
| B7        | Euro III             |            | Yes         | 2011        | Diesel        | 7                      | 0.6           | 0.76                   | 0.78          | 188                    | 93            |    |
| B8        | Euro III             |            | No          | 2011        | Diesel        | 11                     | 1.2           | 31                     | 11            | 1421                   | 346           |    |
| B8        | Euro III             |            | No          | 2012        | Diesel        | 25                     | 19            | 59                     | 10            | 3202                   | 1076          |    |
| B9        | Euro III             |            | No          | 2010        | Diesel        | 20                     | 6.9           | 26                     | 13            | 1566                   | 419           |    |
| B9        | Euro III             |            | No          | 2011        | Diesel        | 4.2                    | 2.6           | 29                     | 7.3           | 1571                   | 197           |    |
| B10       | Euro III (Retrofit)  | SCR        | Yes         | 2011        | Diesel        | 33                     | -             | 13                     | 14            | 6                      | 5             |    |
| B10       | Euro III (Retrofit)  | SCR        | Yes         | 2015        | Diesel        | -                      | -             | 13                     | 10            | 2                      | 0             |    |
| B11       | Euro IV              | SCR        | No          | 2014        | Diesel        | 32                     | 4.8           | 10                     | 2.9           | 150                    | 65            |    |
| B11       | Euro IV              | SCR        | No          | 2015        | RME           | 12                     | 1.4           | 216                    | 6.6           | 542                    | 95            |    |
| B12       | Euro III             |            | No          | 2010        | Diesel        | 6.0                    | 1.8           | 36                     | 13            | 2074                   | 619           |    |
| B12       | Euro III             |            | No          | 2011        | Diesel        | 8.0                    | 1.9           | 70                     | 8.8           | 2259                   | 344           |    |
| B12       | Euro III             |            | No          | 2012        | Diesel        | 12                     | 3.4           | 49                     | 3.2           | 2702                   | 578           |    |
| B13       | EEV/Euro V           |            | No          | 2011        | Methane       | 98                     | 15            | 0.38                   | 0.75          | 10                     | 5             |    |
| B13       | EEV/Euro V           |            | No          | 2012        | Methane       | 83                     | 20            | 3.66                   | 2.6           | -                      | 0             |    |
| B14       | EEV/Euro V           |            | No          | 2010        | Methane       | 57                     | 2.9           | 0.39                   | 0.76          | 60                     | 15            |    |
| B14       | EEV/Euro V           |            | No          | 2011        | Methane       | 68                     | 16            | 2.3                    | 2.7           | 5.9                    | 1             |    |
| B15       | EEV/Euro V           |            | No          | 2011        | Methane       | 4.1                    | 6.1           | 36                     | 43            | 12                     | 8             |    |
| B15       | EEV/Euro V           |            | No          | 2014        | Methane       | 10                     | 11            | 50                     | 39            | 42                     | 23            |    |
| B16       | EEV/Euro V           |            | No          | 2010        | Methane       | 66                     | 20            | 0.33                   | 0.42          | 49                     | 24            |    |
| B16       | EEV/Euro V           |            | No          | 2011        | Methane       | 56                     | 5.6           | 1.3                    | 1.6           | 0.32                   | 0             |    |

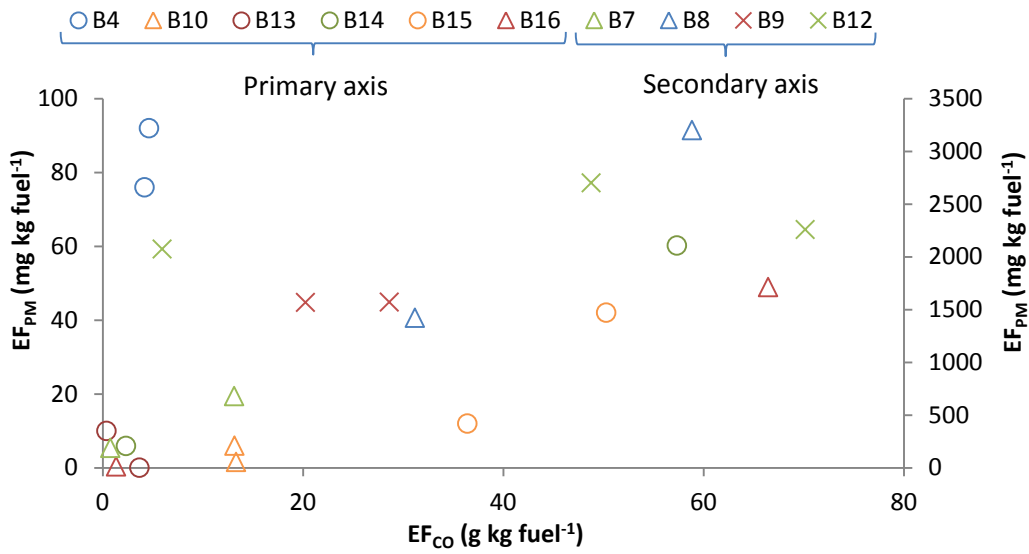

Figure 9 EF<sub>PM</sub> and EF<sub>CO</sub> of buses that have been tested at multiple occasions, excluding buses where there has been a fuel switch. The secondary y-axis is for B7, B8, B9 and B12.

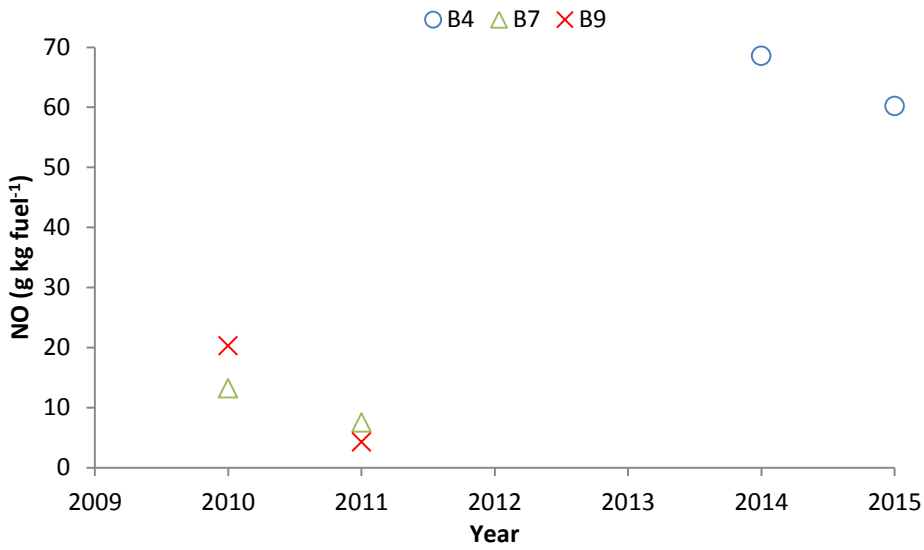
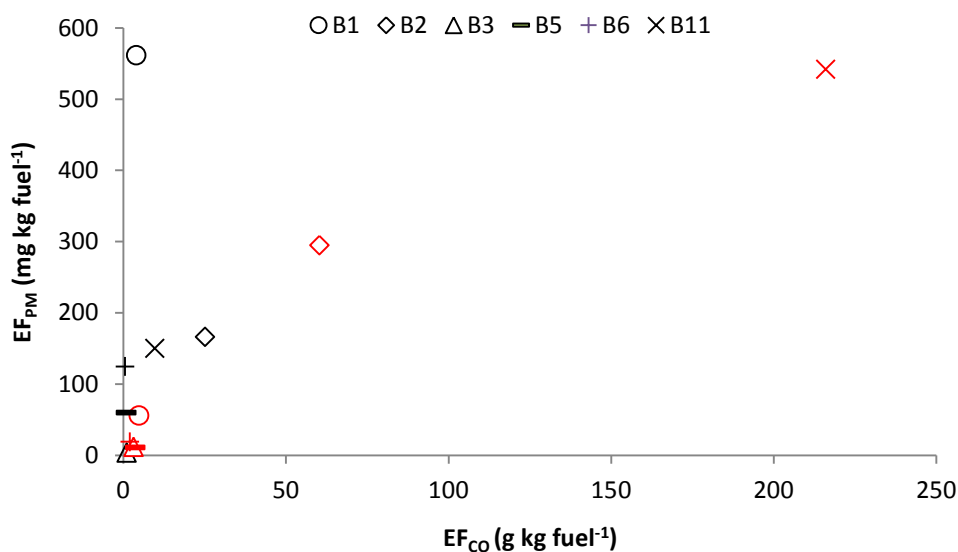

Figure 10 EF<sub>NO</sub> of buses that have been tested at multiple occasions, excluding buses where there has been a fuel switch and where the changes were not statistically significant.

## 5.1.5 Emission differences of buses tested both on diesel and 100% RME

For six of the buses (B1, B2, B3, B5, B6 and B11) there was a fuel switch from diesel to RME between the two occasions the bus was tested and both a decrease (B1, B5 and B6) and an increase (B2, B3 and B11) in  $EF_{PM}$  when running on RME compared to diesel were observed. The emission standard of B1, B2 and B11 was Euro IV and Euro V for B3, B5 and B6.

B1 was in 2014 converted to be operated on 100% RME. Also the particulate filter was washed in March 2015 (four months before the measurements). The lower emissions in 2015 compared to 2010 may be a consequence of both the conversion to RME and/or the newly washed particulate filter. Both B5 and B6 were converted to be operated by 100% RME and the particle emissions were significantly lower in 2015 compared to 2012 (Figure 11). Common for these buses is that the combustion conditions were similar (i.e. small difference in  $EF_{CO}$ ) at both occasions the bus was tested, indicating a general reduction in  $EF_{PM}$  when running on RME compared to diesel (Figure 11).



**Figure 11**  $EF_{PM}$  for buses that have been tested at multiple years and where there has been a fuel switch (red symbols are  $EF_{PM}$  when fuelled with RME).

For B2, B3 and B11 the particle emissions were higher when running on RME compared to diesel. B2 was converted to RME operation sometime between 2011 and 2015 and B11 was converted between 2014 and 2015. However, for B2 and B11 also the  $EF_{CO}$  was much higher when running on RME (Figure 11 and Table 3), indicating more incomplete combustion, hence favouring soot formation. It is therefore difficult to distinguish between impact of fuel and impact of different combustion conditions on the emissions.

B3 was converted to RME operation sometime between 2010 and 2015 and there was a slight increase in particle mass emitted when running on RME and also the CO emission increased somewhat. However, the CO emission was much lower compared to B2 and B11. Additionally, B3 was equipped with DPF so another possibility for the increase in particle mass emitted besides fuel and combustion condition is the performance of the DPF.

For three of the buses (B5, B6 and B11) the measured difference in  $EF_{NO}$  was statistically significant (Figure 12). B5 and B6 showed an increase of NO emissions when fuelled with RME compared to diesel and B11 showed the opposite trend. B11 did even show a significant increase of  $EF_{PM}$  and  $EF_{CO}$  but the reason for the lower  $NO_x$  emission is hard to determine without knowing more about the bus/engine. Since it was equipped with an SCR catalyst it may just be a consequence of better operating conditions of the catalyst at the second measurement occasion.

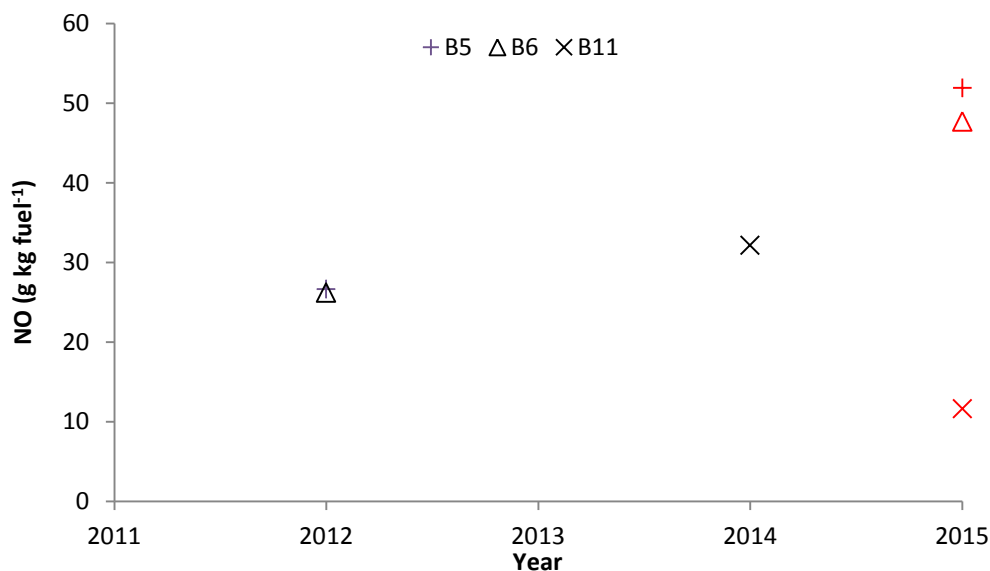

Figure 12  $EF_{NO}$  for buses that have been tested at multiple years and where there has been a fuel switch (red symbols are  $EF_{NO}$  when fuelled with RME).

## 5.2 On-road measurements

This section presents  $NO_x$  emissions and  $NO_2/NO_x$  ratios measured from the roadside with the RSD<sub>DU</sub> in 2014. For comparison, measured  $NO_2/NO_x$  ratios are compared to ratios measured during the controlled acceleration measurements and also to ratios from the HBEFA model.

## 5.2.1 NO<sub>x</sub> differences between manufacturers/Technology

The by far most frequent emission standard measured among the buses from the roadside was Euro V (this was also the case with the controlled measurements at the bus depots). Among the measured Euro V buses one manufacturer was dominating. There were also three other manufacturers that were represented to an extent that an analysis of differences in NO<sub>x</sub> between the brands was possible. This is interesting since different manufacturers may use different versions of exhaust aftertreatment systems that may result in e.g. different levels of emitted NO<sub>x</sub> and NO<sub>2</sub>/NO<sub>x</sub> ratios. It is also interesting to compare NO<sub>x</sub> emissions measured from the roadside with measured emissions from the controlled acceleration measurements.

Table 4 presents measured NO<sub>x</sub> emissions together with information on emission standard, NO<sub>x</sub> reducing technology, manufacturer and number of measurements. Comparing emissions from the SCR equipped Euro V buses (M1 and M2) show that the differences in median and average NO<sub>x</sub> emissions are quite large. However the number of measurements of M2 is low and this is reflected in the confidence interval. Comparing to the measured NO<sub>x</sub> from M1 and M2 during the controlled acceleration measurements for buses from the same manufacturers, the difference is similar to what is observed from the roadside which may indicate lower on-road NO<sub>x</sub> emissions from M2 compared to M1. The NO<sub>2</sub>/NO<sub>x</sub> ratio between M1 and M2 are similar though.

The EGR equipped buses (M3 and M4) shows similar levels of NO<sub>x</sub> emissions but the average NO<sub>2</sub>/NO<sub>x</sub> ratio differs greatly (5% vs 41%). One possible reason may be due to different techniques used for particle reduction, but this could not be confirmed during this study.

Only two different Euro VI buses were measured from the roadside (total 6 measurements) and the NO<sub>x</sub> emissions were low, similar to the observations from the controlled measurements during acceleration. The NO<sub>2</sub>/NO<sub>x</sub> ratio was measured to 29% from roadside and 22% during the controlled measurements. It should be noted though that this is a ratio of two low averages based on a small number of measurements which makes the ratio uncertain.

**Table 4 EF<sub>NOx</sub> (g kg fuel<sup>-1</sup>) measured from the roadside and NO<sub>2</sub> share of NO<sub>x</sub> measured during the controlled acceleration measurements, from the roadside and ratios taken from the HBEFA model.**

| Euro Standard | Technol. | Brand | # (total) | # (unique) | EF <sub>NOx</sub> |         |        | NO <sub>2</sub> /NO <sub>x</sub> |            |           |
|---------------|----------|-------|-----------|------------|-------------------|---------|--------|----------------------------------|------------|-----------|
|               |          |       |           |            | Median            | Average | 95% CI | Roadside                         | Controlled | HBEFA     |
| E III         | -        | Mix   | 10        | 7          | 43                | 42      | 7      | 5%                               | -          | 7% (30%)  |
| E V / EEV     | SCR      | M1    | 246       | 116        | 41                | 43      | 3      | 2%                               | 1%         | 7% (25%)  |
| E V           | SCR      | M2    | 8         | 4          | 26                | 29      | 19     | 2%                               | -          | 7% (25%)  |
| E V / EEV     | EGR      | M3    | 173       | 79         | 20                | 25      | 2      | 5%                               | -          | 21% (25%) |
| E V           | EGR      | M4    | 19        | 13         | 21                | 21      | 4      | 41%                              | -          | 21% (25%) |
| E VI          | SCR+EGR  | M1    | 6         | 2          | 1                 | 2       | 3      | 22%                              | 29%        | -         |



## 5.2.2 Buses compared to passenger cars

Two of the three locations used for roadside measurements did allow measurements of mixed vehicle types consisting of mostly passenger cars, buses and light duty vehicles. Figure 13 shows measured average  $\text{NO}_x$  emissions from diesel passenger cars and buses. The trend seen for buses (see Figure 1), with no significant decrease in  $\text{NO}_x$  emissions when going from Euro III to Euro V and then a significant reduction from Euro V to Euro VI, was also observed for passenger cars. The emissions are here presented on a fuel basis and the emissions between passenger cars and buses do not differ much then. However, distance specific emissions will differ since different vehicle types have different fuel consumptions.

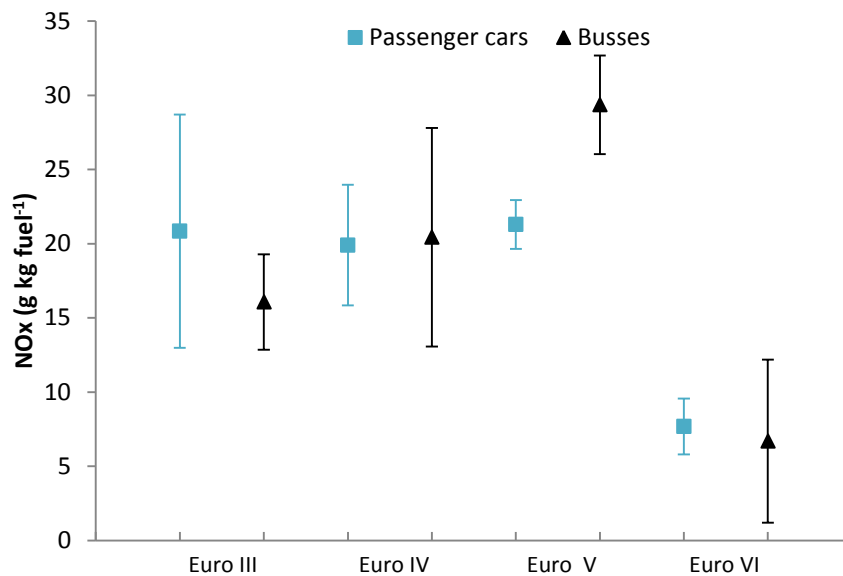

Figure 13  $\text{EF}_{\text{NO}_x}$  emissions ( $\text{g kg fuel}^{-1}$ ) from diesel passenger cars and diesel buses. Stated errors are at the statistical 95% confidence level.

## 6 Conclusions and discussion

After five years of emission measurements on buses IVL has an extensive amount of emission data for buses of different Euro classes, exhaust aftertreatment systems etc. This enables in depth analysis of emission trends, e.g. by Euro class, in addition to identifying high emitting busses

During 2014 IVL measured emissions from some of the first Euro VI buses used in traffic. These buses showed a significant decrease in emissions of both NO<sub>x</sub> and particles compared to Euro V buses. This is especially interesting when it comes to NO<sub>x</sub> since the measurements have shown no significant decrease throughout the Euro standards, going from Euro III to Euro V. However, for particle mass there is a decreasing emission trend going from Euro III to Euro VI with an exception of Euro IV buses with EGR.

The median NO emission from methane fuelled vehicles is at the same level as, e.g., Euro III diesel buses. An analysis of the measured emissions by model year, age of the bus when tested and manufacturer showed that there was no obvious relationship between vehicle age and NO emissions. There were however differences between different manufacturers where one had higher average emissions than the others. The reasons for this were not further investigated since it was outside the scope of this study.

The most common Euro standard among the tested buses was Euro V. Among the Euro V buses there was also a mix of buses fuelled with (low blended) diesel and 100% RME. This enabled an analysis of the influence of fuel type on the emissions. To eliminate as many other parameters as possible that could influence the emissions, the analysis was carried out for Euro V buses from only one manufacturer which uses an SCR-system for NO<sub>x</sub> reduction. The median emission of particle mass from buses running on 100% RME was much lower, 88%, compared to the buses fuelled with diesel. The same analysis of NO<sub>x</sub> emissions resulted in higher (35%) median emission for buses driving on 100% RME compared to diesel. This difference is however more uncertain compared to the difference in the particle emissions; especially since the NO<sub>x</sub> emission is heavily dependent on the exhaust gas temperature and other parameters that determine the efficiency of the SCR system.

Some of the buses have been tested more than once during 2010-2015. Many of these buses did not show any significant differences between the years, but some did. Especially interesting is the comparison of emissions from six buses that were fuelled with (low blended) diesel at the time of the first test and 100% RME at the time of the second test. Three of these buses showed a decrease in PM emissions when fuelled with RME, whereas the other three showed an increase. In the latter case also the CO emissions increased which indicates incomplete combustion. This means that a conversion to 100% RME may lead to reduced particle mass emissions but also that some of the buses which changed from diesel to RME may have had problems related to the combustion efficiency that undermines this reduction.

Data from the measurements described in this report show some interesting results. However, some of the results would require further analyses to be explained. Examples that would have

been interesting to investigate further are the reason for the large differences in  $EF_{NO}$  from methane fuelled buses, the high  $EF_{PM}$  of some Euro IV EGR buses, the higher  $EF_{PM}$  and  $EF_{CO}$  for some buses when driving on 100% RME compared to diesel and the difference in  $NO_2/NO_x$  from different manufacturers of Euro V buses with EGR. Some of these questions may be answered in coming studies both through further analyses of data from already conducted measurements but also from new measurements. If more measurements will be conducted more work should also be put on getting detailed information about each bus such as time since last service, age and maintenance of the particle filter, age of the catalyst of methane powered vehicles and more. This may give important information e.g. when trying to explain the emission behaviour of both individual buses and groups of buses with the same emission performance. It would also be interesting to receive more feedback from the bus operators when it comes to the buses that IVL has identified as potential high emitters. In some cases the feedback about what was found during the inspection that followed the measurement was informative but in some cases not. The reason for this varies from case to case but the information on if the measurements really did identify some malfunction of the bus would be of great interest for the study.

## References

Burgard, D. A., Dalton, T. R., Bishop, G. A., Starkley, J. R., & Stedman, D. H. (2006). Nitrogen dioxide, sulfur dioxide, and ammonia detector for remote sensing of vehicle emissions. *Review of Scientific Instrument* 77.

Hallquist, Å. M., Jerksjö, M., Fallgren, H., Westerlund, J., & Sjödin, Å. (2013). Particle and gaseous emissions from individual diesel and CNG buses. *Atmospheric Chemistry and Physics* 13, 5337-5350.

Jerksjö and Hallquist (2013), Avgasmätningar på bussar i verklig drift för identifiering av högemitterare, IVL B2090

Persson J, *et al.*, (2010) Nanoparticle emissions from road traffic, AbstractGAC Conference, 2010

HBEFA, 2015 – [www.hbefa.net](http://www.hbefa.net)

# Appendix 1

**Table 5 Bus operators at which IVL have conducted measurements.**

| <b>Bus operator</b> | <b>Location</b>      | <b>Year of measurement</b> |
|---------------------|----------------------|----------------------------|
| Borås Lokaltrafik   | Borås                | 2010, 2011, 2012           |
| Göteborgs spårvägar | Kville               | 2010, 2012                 |
| Göteborgs spårvägar | Kruthusgatan         | 2015                       |
| Keolis              | Grimbo               | 2015                       |
| Keolis              | Partille             | 2012                       |
| KE´s buss           | Fjärås               | 2011                       |
| LEBU                | Kungälv              | 2015                       |
| Nettbuss            | Bergslagsgatan       | 2012, 2014                 |
| Nobina              | Ale                  | 2011                       |
| Nobina              | Skövde               | 2010                       |
| Nobina              | Trollhättan          | 2015                       |
| Omnibuss            | Uddevalla            | 2010, 2015                 |
| Orustrafiken        | Kungsbacka           | 2010                       |
| Söne buss           | Stenkullen           | 2011                       |
| Veolia              | Borås                | 2011                       |
| Veolia              | Göteborg - Frihamnen | 2011, 2014, 2015           |
| Vårgårda buss       | Vårgårda             | 2012                       |





IVL Swedish Environmental Research Institute Ltd.  
P.O. Box 210 60 // S-100 31 Stockholm // Sweden  
Phone +46-(0)10-7886500 // Fax +46-(0)10-7886590 // [www.ivl.se](http://www.ivl.se)